

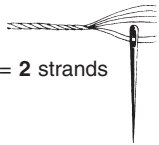





PERMIN

Scandinavian art needlework



Work with split yarn = 2 strands



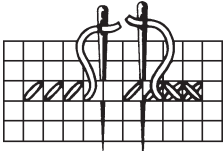

 603. ROSE	 3345. DARK GREEN
 601. DARK ROSE	 3325. BLUE
 777. BORDEAUX	
 989. LIGHT GREEN	

Cross stitches



For this design please use Permin aida fabric. Item no. 357 in colour 22 (357/22)

1  = 1  in the fabric
Count the design from centre of fabric

Work with split yarn = 1 strand

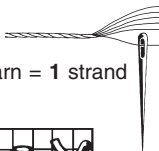

Back stitches

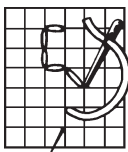

3371.

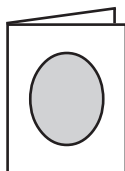
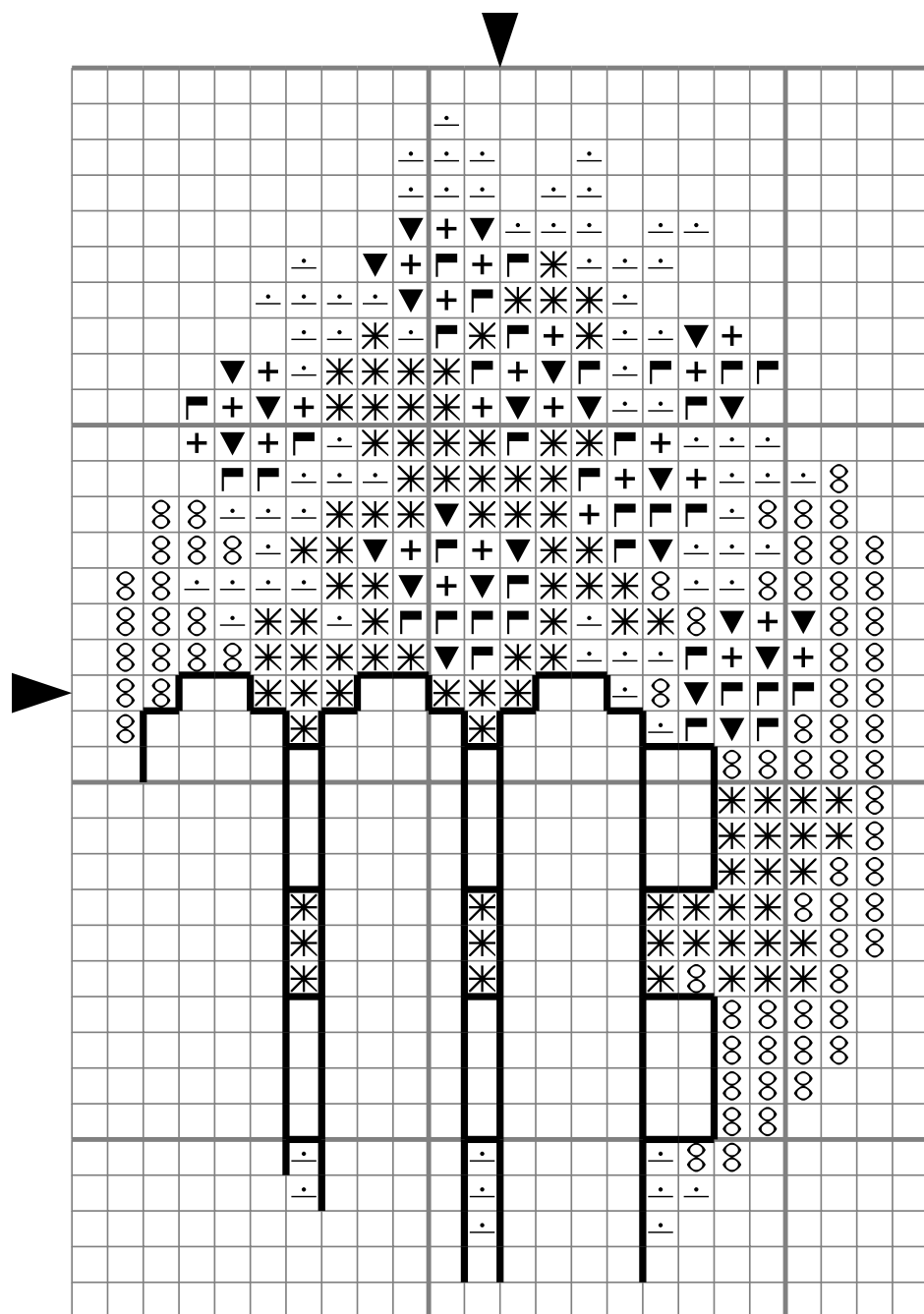

CARD & ENVELOPE
NO. 5875/00



Made in Denmark©